



Моделирование компрессорного стенда

DYNAMICS R4

Научно-технический центр “Альфа-Транзит”



Компрессорный стенд

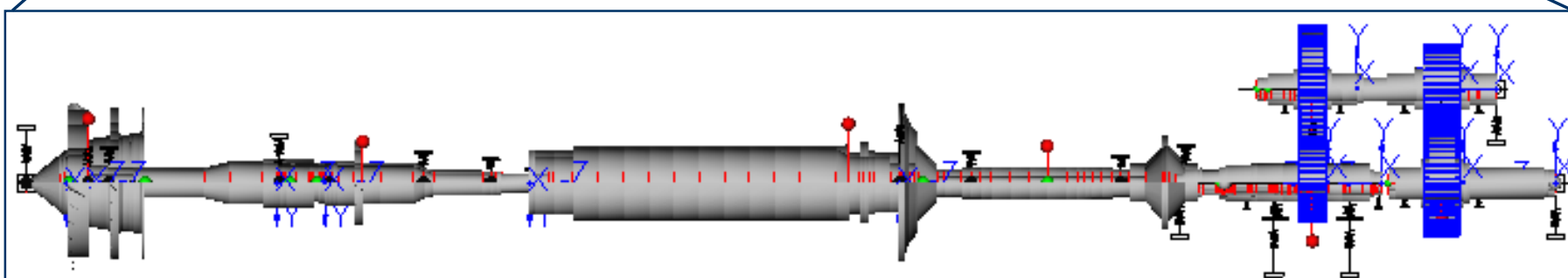
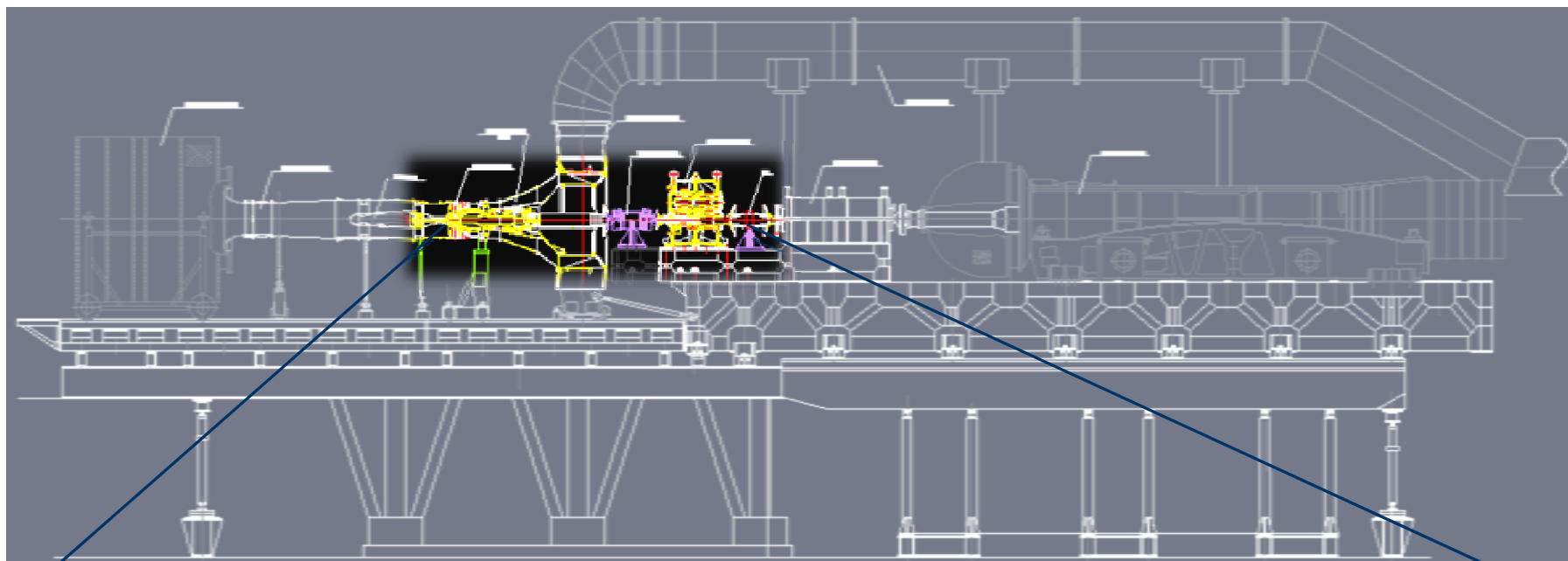

DYNAMICS R4

НТЦ "Альфа-Транзит"
(495)232-60-91
www.alfatran.com

Моделирование валопровода стенда

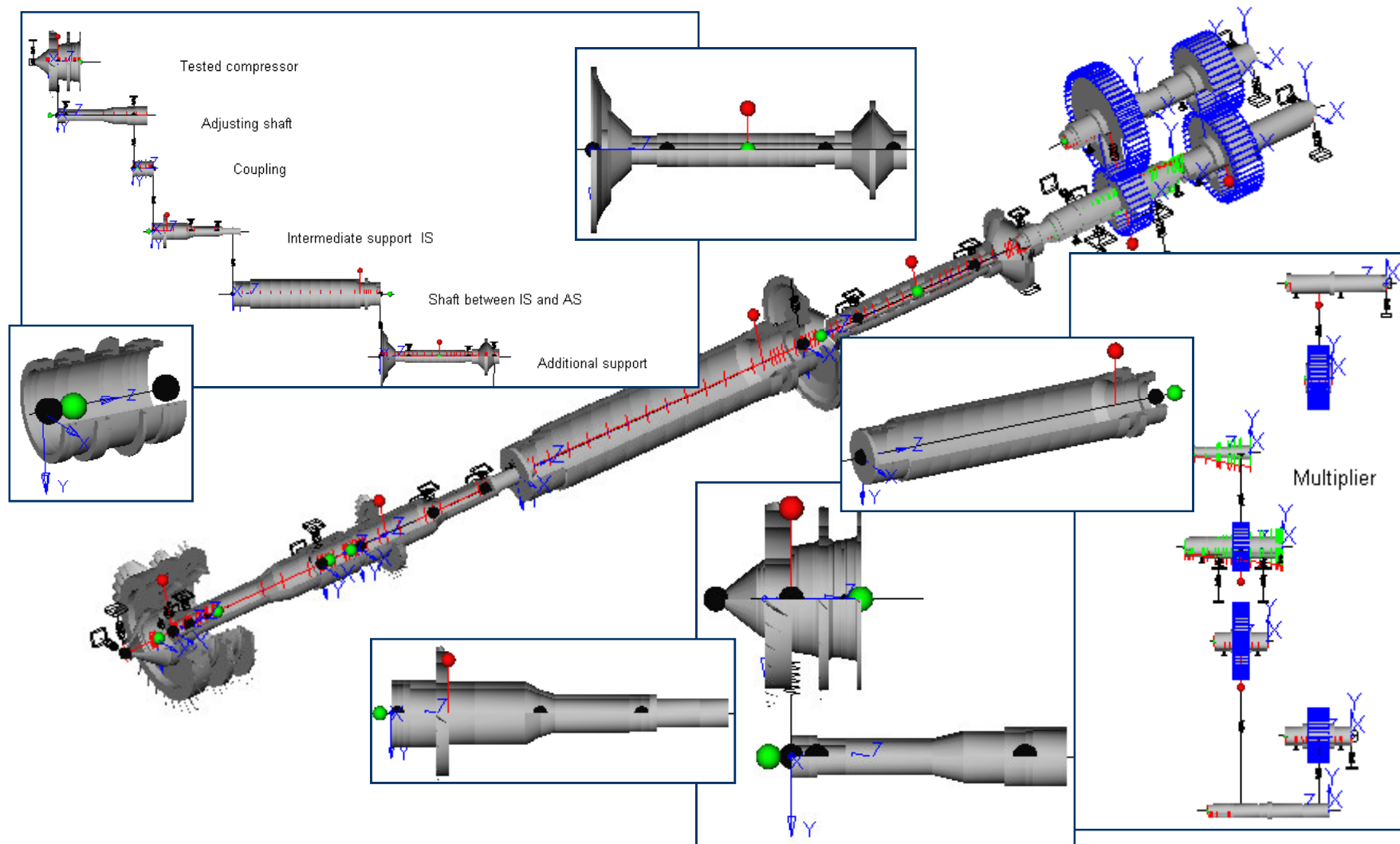

Мультипликатор

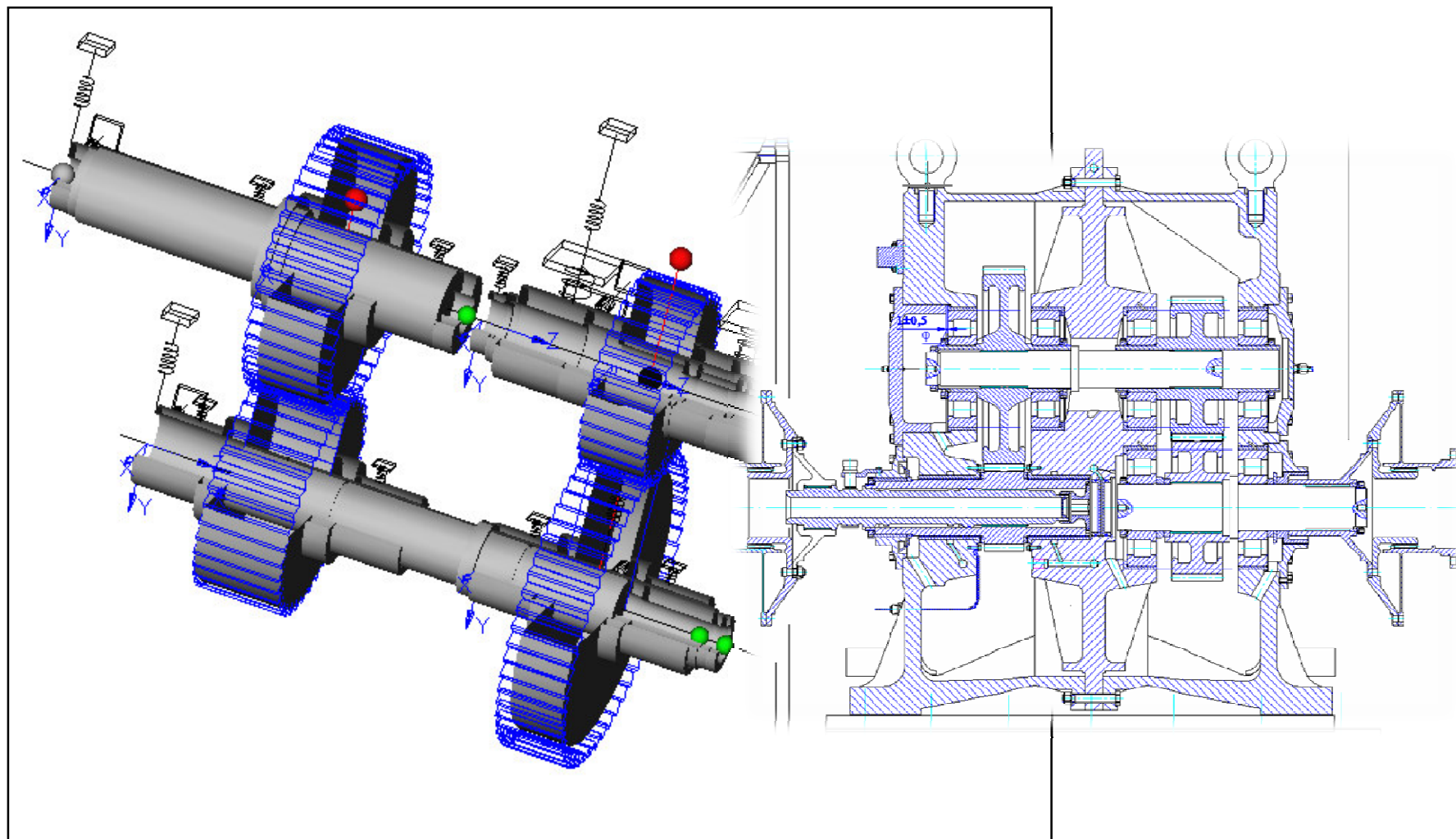

DYNAMICS R4

НТЦ "Альфа-Транзит"
(495)232-60-91
www.alfatran.com

Частоты и формы колебаний

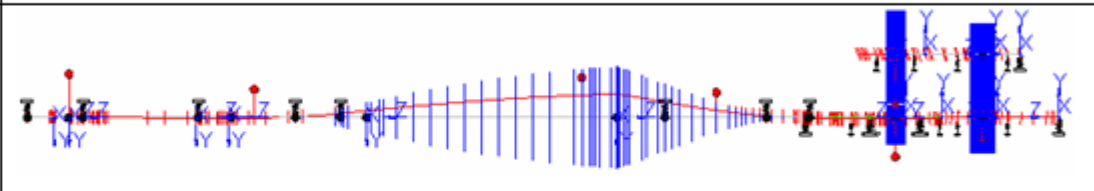
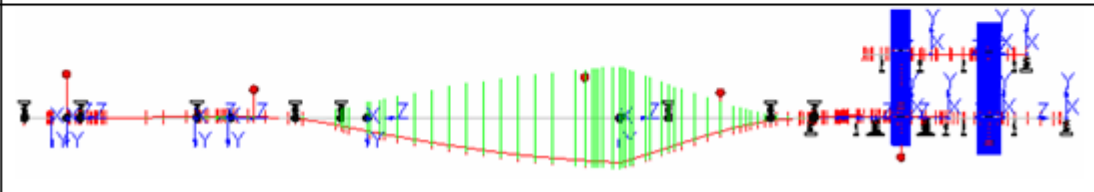
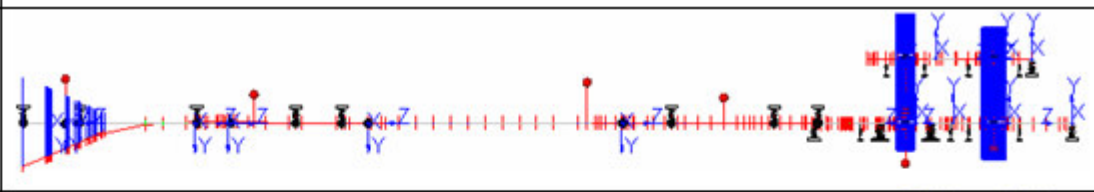
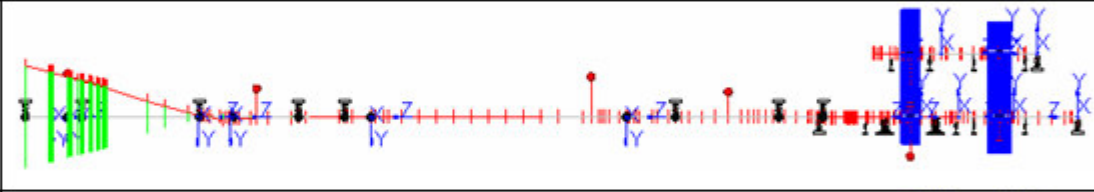
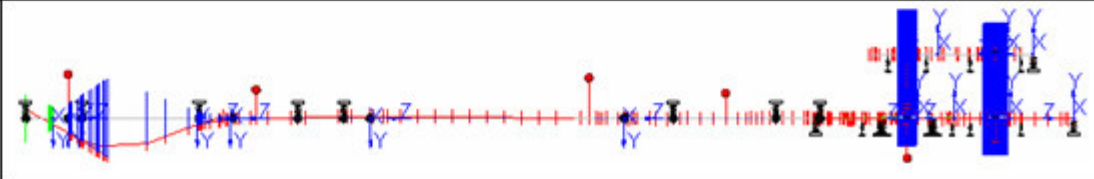
Критическая частота, об/мин	Форма колебаний
6274	
6440	
9533	
10774	
13069	

Частоты и формы колебаний

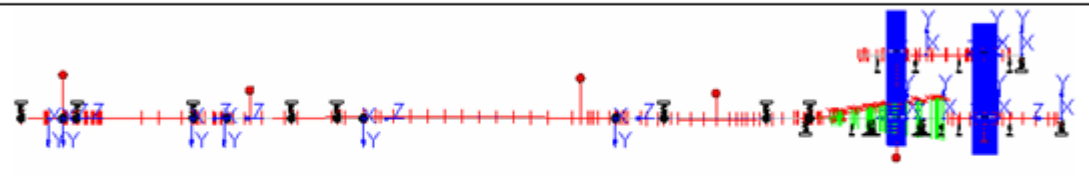
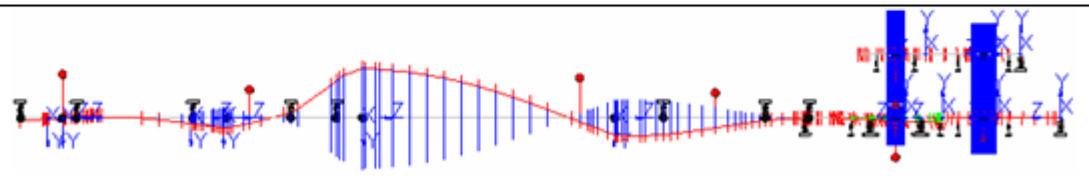
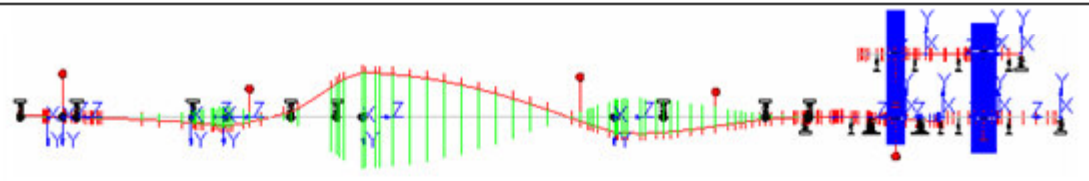
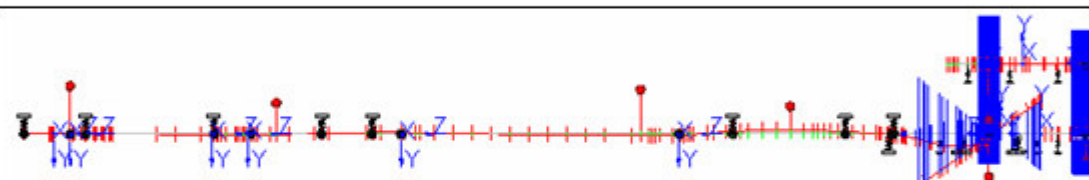
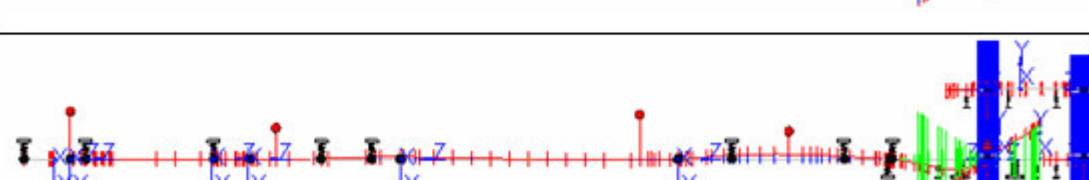
Критическая частота, об/мин	Форма колебаний
13122	
15096	
15580	
24084	
29704	

Распределение энергии

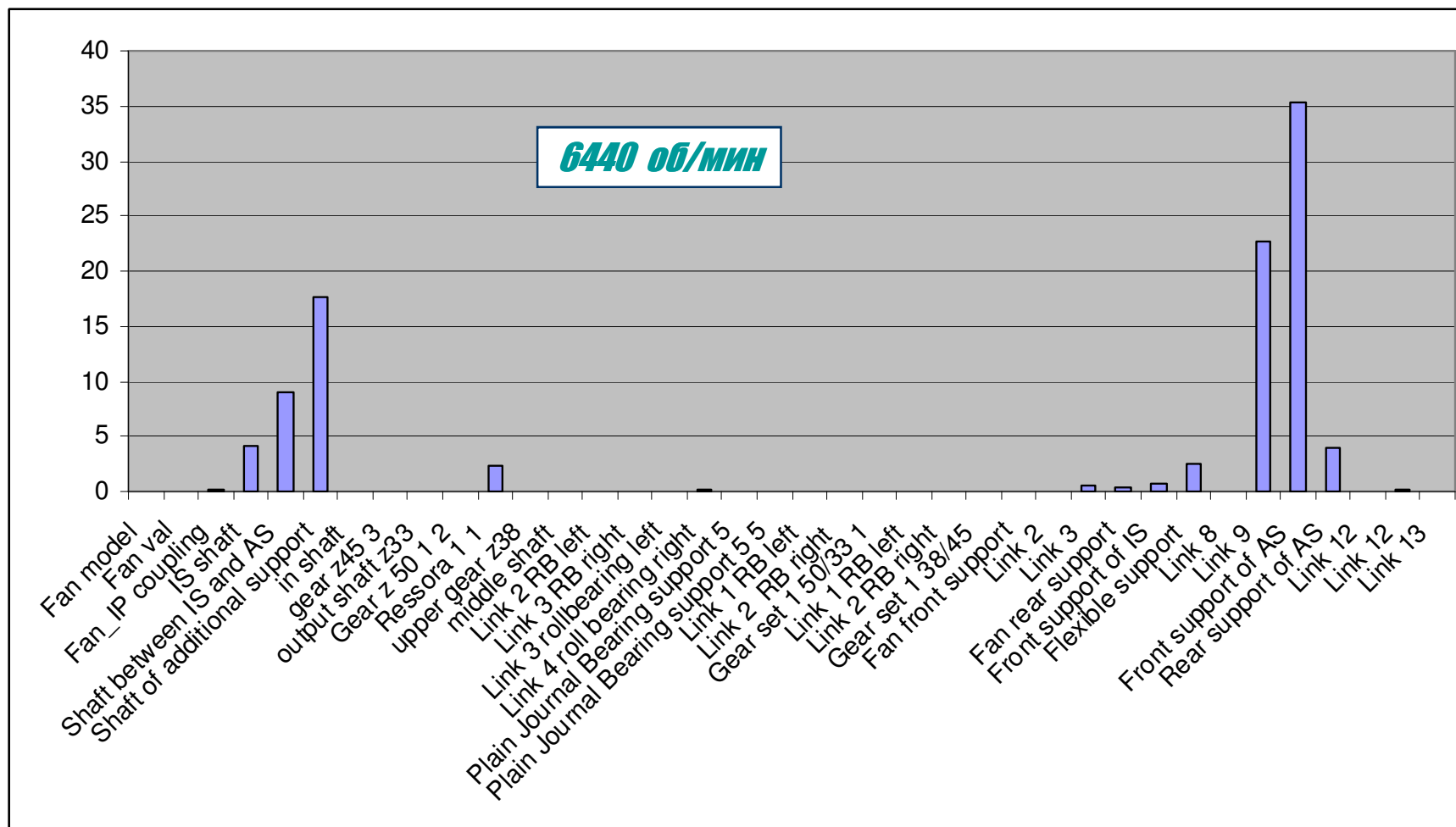

Распределение энергии

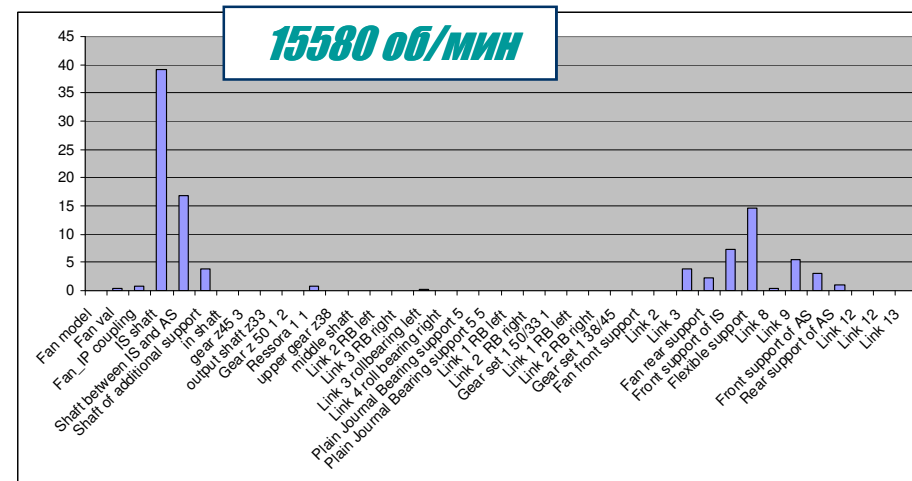
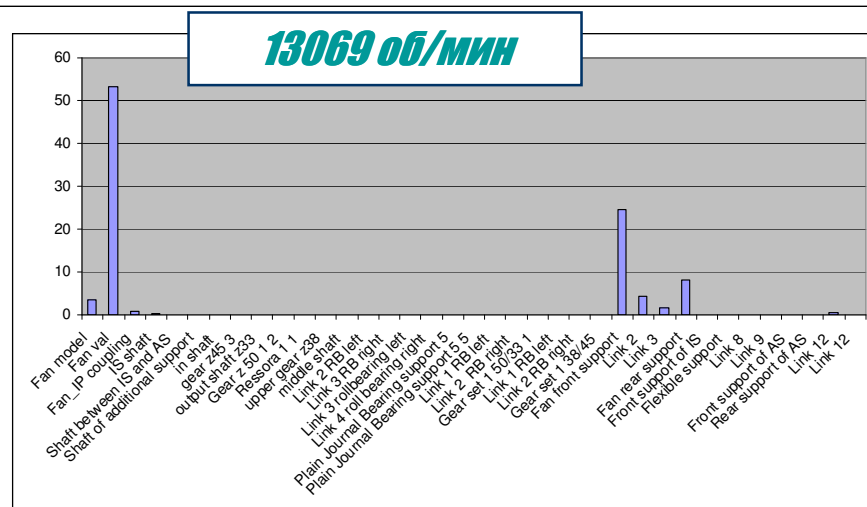
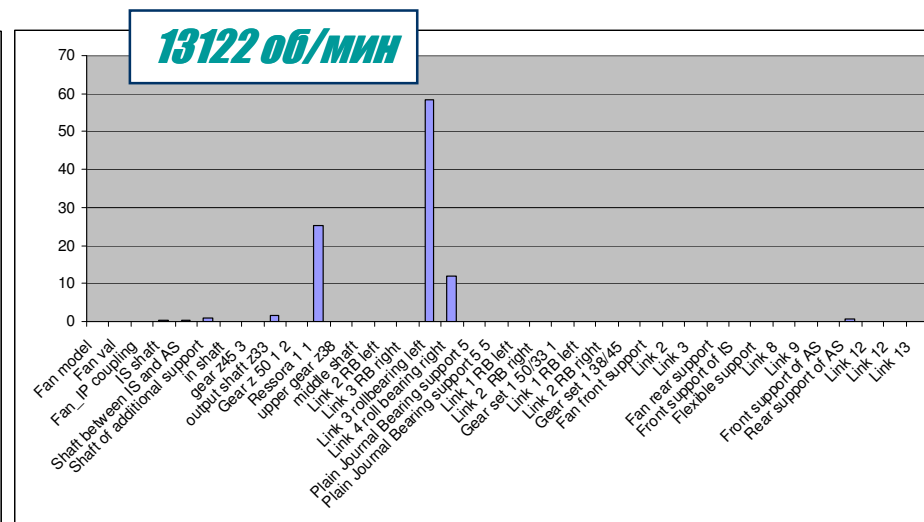
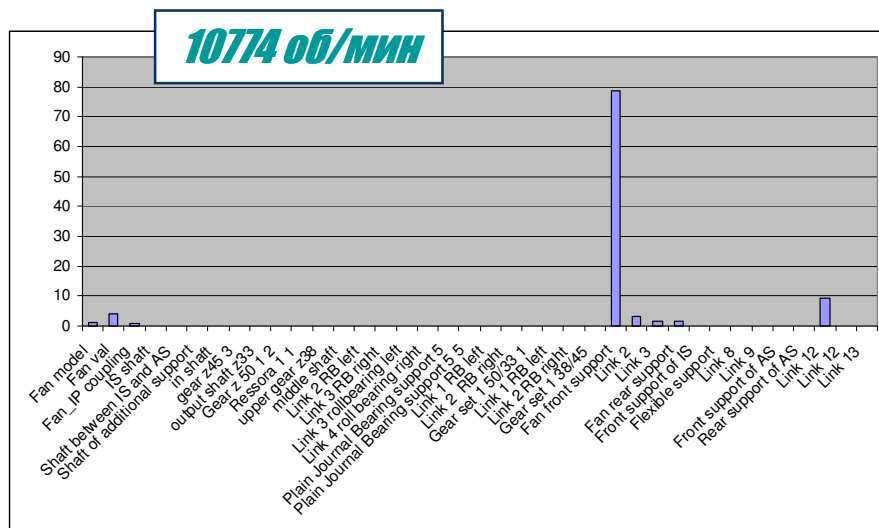

Дисбалансное поведение



Unbalance response

[Fan val]. [568 Fan rear support]. [6.4.2008 (10:50)]

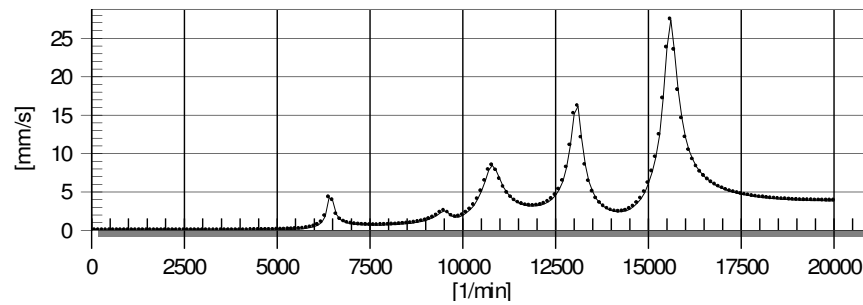

Unbalance response

[Shaft of additional support]. [2412.5 Front support of AS]. [6.4.2008 (10:59)]

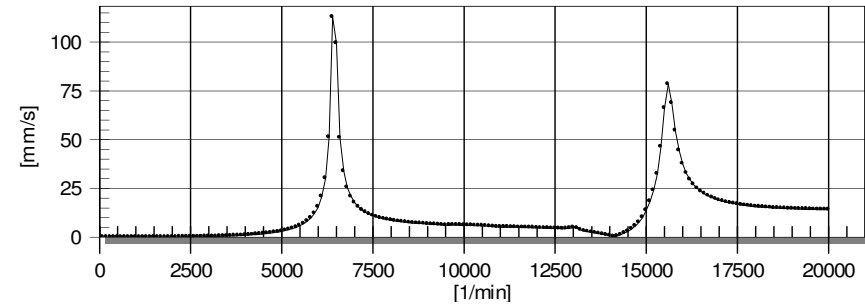

Unbalance response

[output shaft z33]. [3498.4 Link 3 rollbearing left]. [6.4.2008 (11:4)]

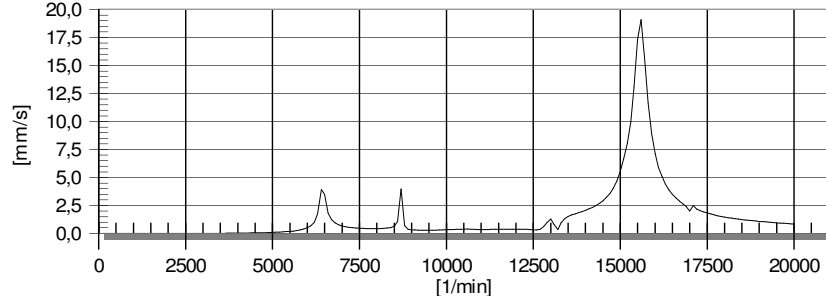

Unbalance response

[IS shaft]. [1131 Flexible support]. [6.4.2008 (11:2)]

